

Guidance Notes

Our kits can be assembled easily using the following instructions and can be used on their own or joined together to create whichever configuration you might want.

We want you to enjoy your deck purchase for many years to come and by following a few simple steps you will be able to ensure this happens.

Please take time to read the assembly instructions carefully before erecting your decking kit and check all parts prior to assembly.

Ensure before starting construction that you have a level working area to install your frame, be this on paving slabs, gravel or well draining ground (grass/soil).

To complete your build you may also require Membrane, Fascia Boards, Corner Dolly's, Stain, Handrails and Additional Joists to strengthen which are not provided as part of a standard kit.

Please Note: In some instances your joists and hand/base rails may require trimming to size to make your frame the correct / exact size.

Maintenance

All timber decking can become slippery when wet or in situations where standing water is present. You should exercise caution when the surface is wet.

It is important that the deck surface is kept clean by regular brushing with a stiff bristle brush to remove dirt, algae and dead leaves which could make the deck slippery in the wet.

Periodic cleaning to remove moss and lichen will reduce the risk of slipping.

We recommend staining, treating or oiling your deck when complete to maximise its lifespan.

Recommended Tools

Drill Driver

PZ2 Driver Bit

Pencil

Tape Measure

Hand Saw

Spirit Level

For all kits we recommend a minimum of two people for safe assembly.

Discount Decking Kit

Fitting Guide

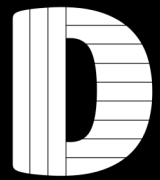

Step 1

LAY YOUR FRAME

This is an example of a decking frame.

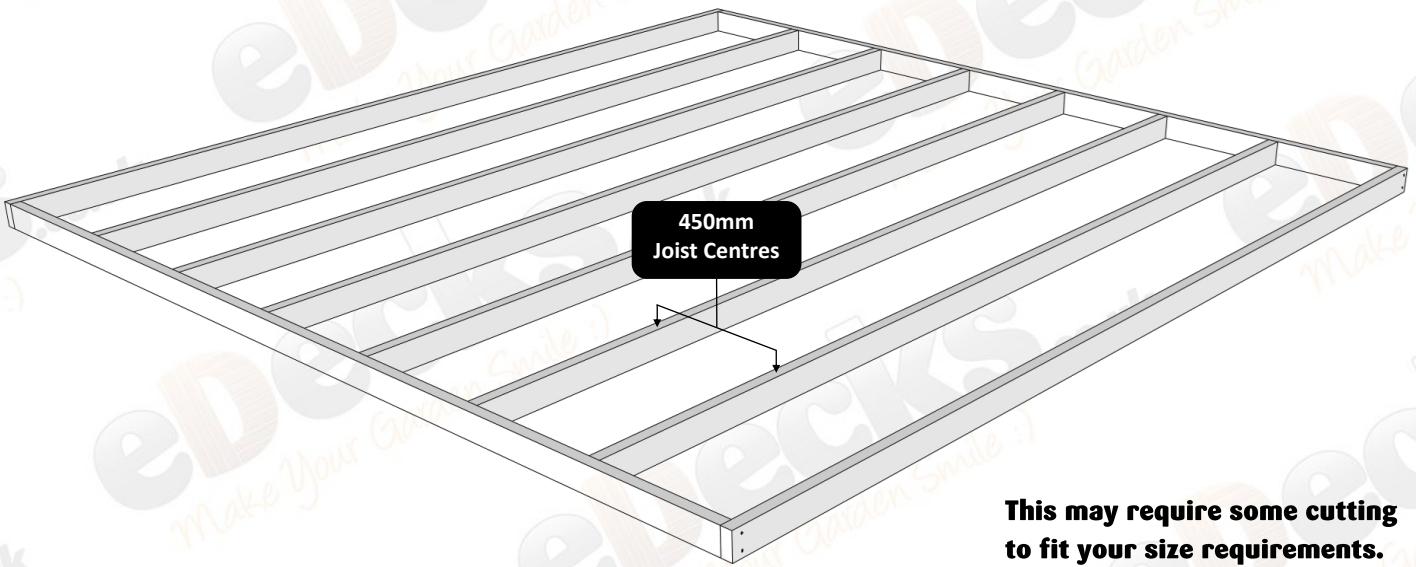

This may require some cutting to fit your size requirements.

Using the decking joists provided in the Kit (3 1/2" x 1 1/2") build the perimeter first then evenly spread the remaining decking joists inside as shown in the example above, using the 4" x 10g joist screws from the fixing kit.

METHOD FOR SCREWING JOISTS

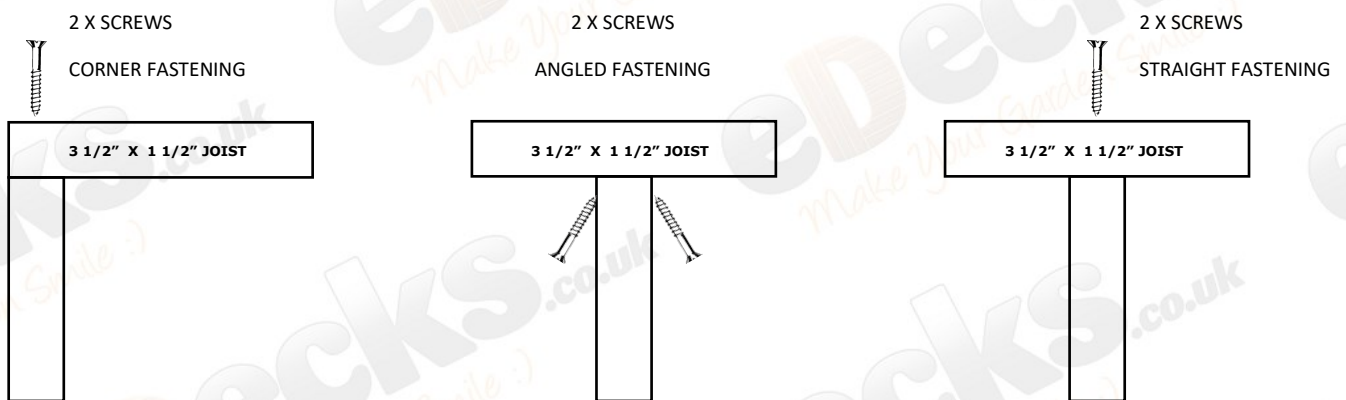

JOIST TOP VIEW

All images are for illustration only. Please see individual item listings for actual item specifications.

Discount Decking Kit

Fitting Guide

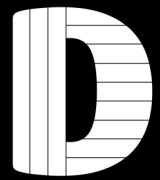

Step 2

FITTING NEWEL POSTS (IF INCLUDED)

If your kit includes handrails please follow the instructions on this page, if not you can proceed to the next step.

Each newel needs securing in each corner (**Fig A**) and depending on your kit size might also need securing on the side (**Fig B**) do so using the Carriage Bolts.

Install all the newels so your kit begins to look like the below diagram.

A. SECURE AT CORNER

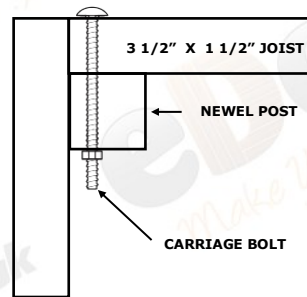

B. SECURE AT SIDE

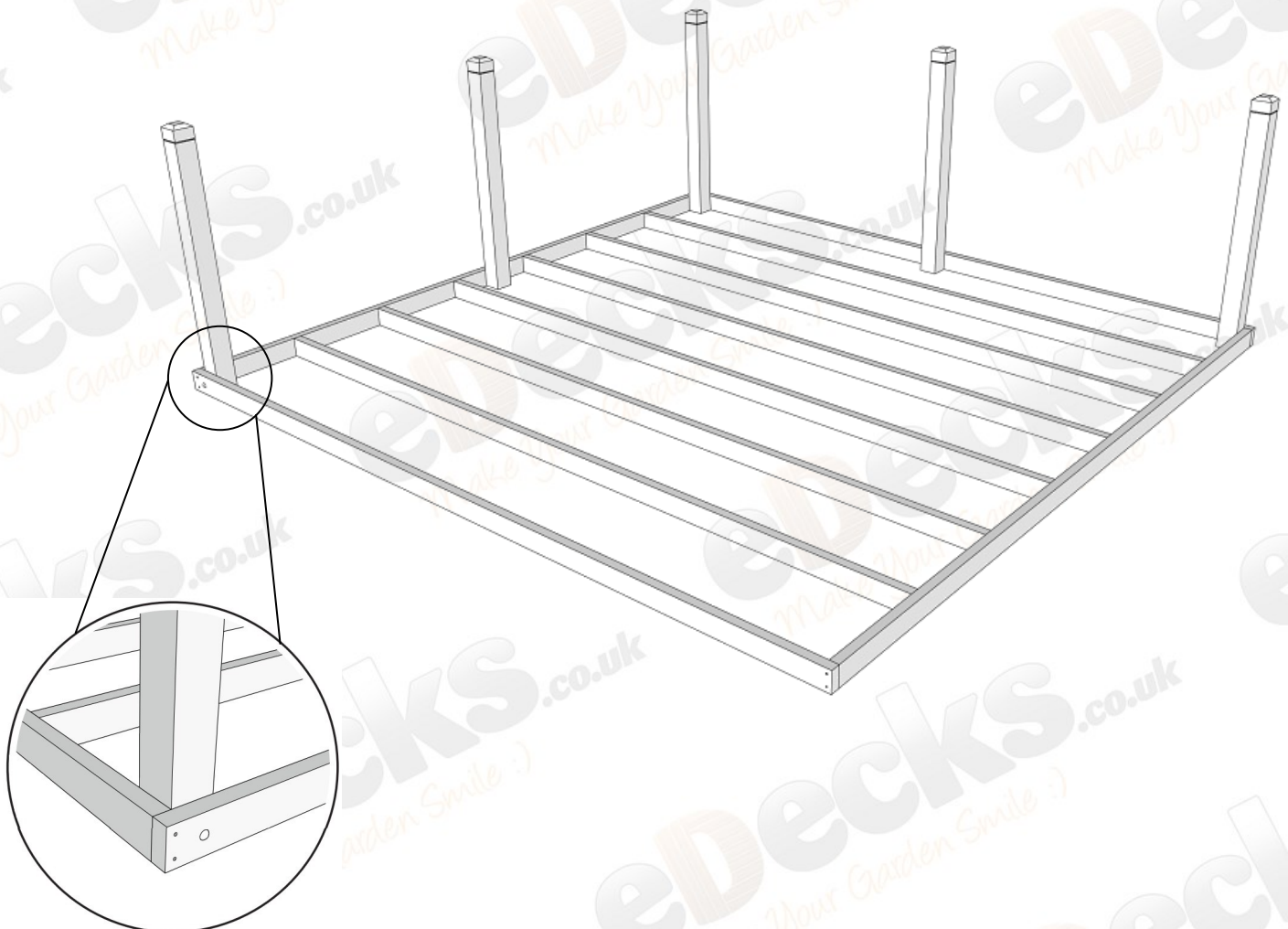
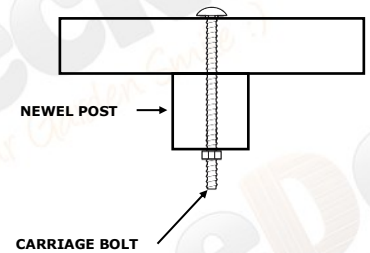

All images are for illustration only. Please see individual item listings for actual item specifications.

Discount Decking Kit

Fitting Guide



Step 3

INSTALLING THE DECKING BOARDS

Decking boards should fit exactly to the frame, working in the opposite direction to the joist work, when laying the boards make sure you leave a 6mm gap between each board.

Use 2 x screws per board, per joist

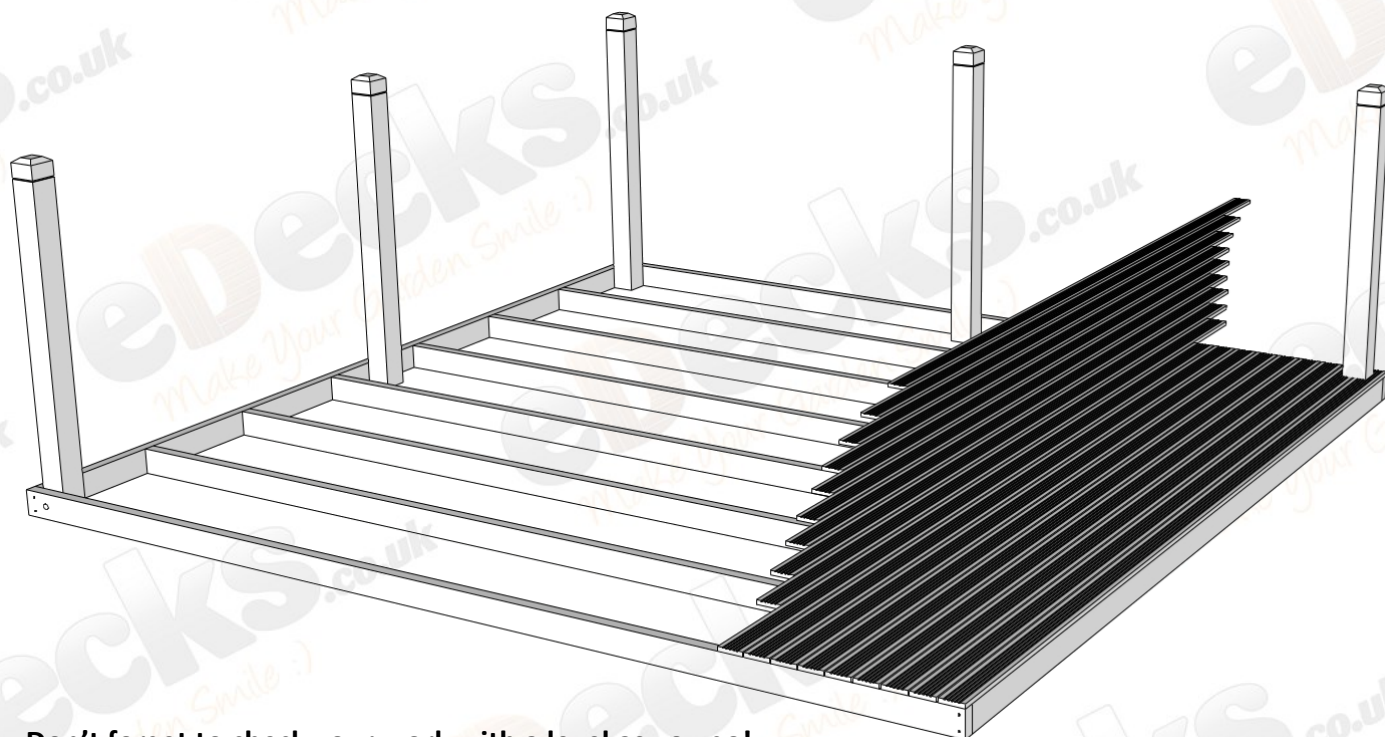

Don't forget to check your work with a level as you go!

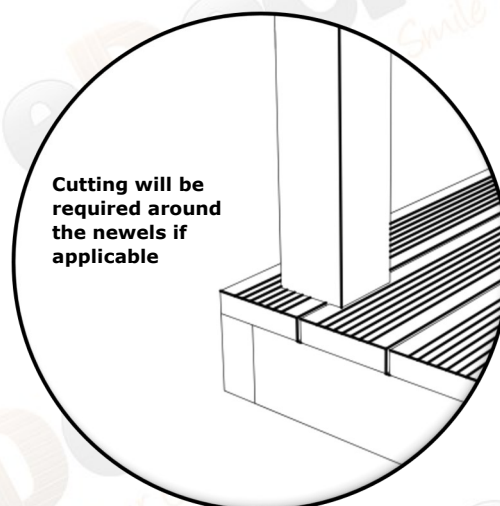
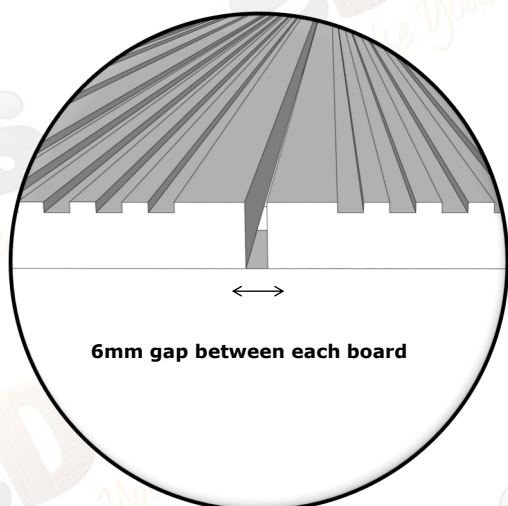

All images are for illustration only. Please see individual item listings for actual item specifications.

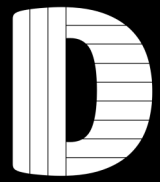

Step 3 Cont'd

INSTALLING THE DECKING BOARDS

With all the deck boards secured in place, your deck should now look as per below.

If you are not installing a handrail system, your build is now complete.

If your kit includes handrails, proceed to step 4.

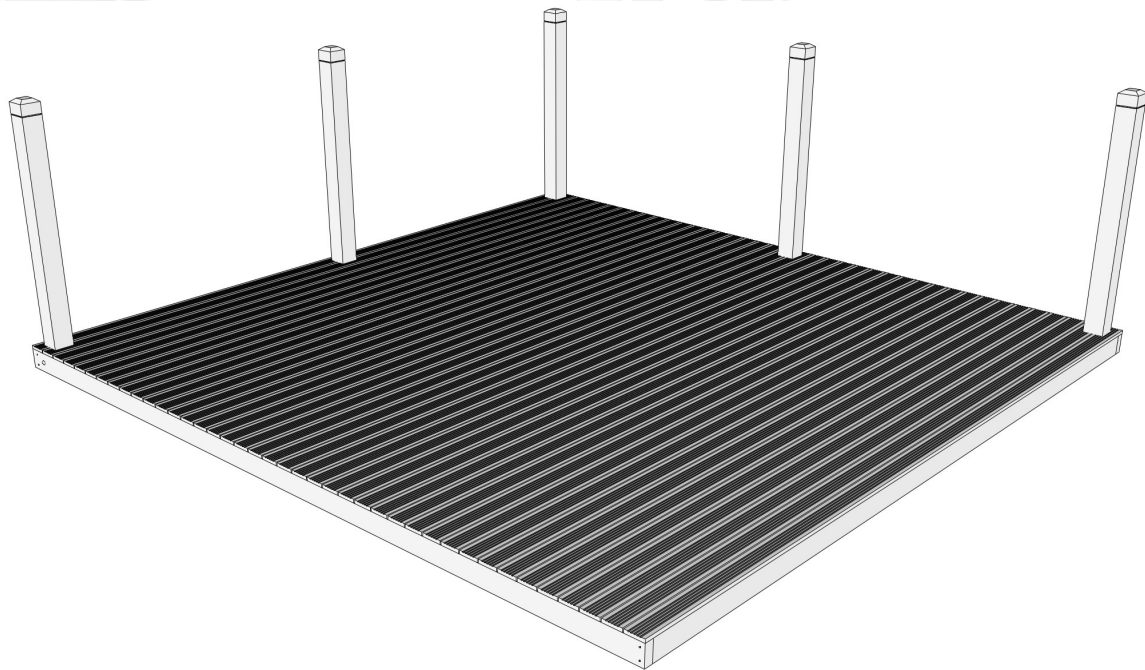
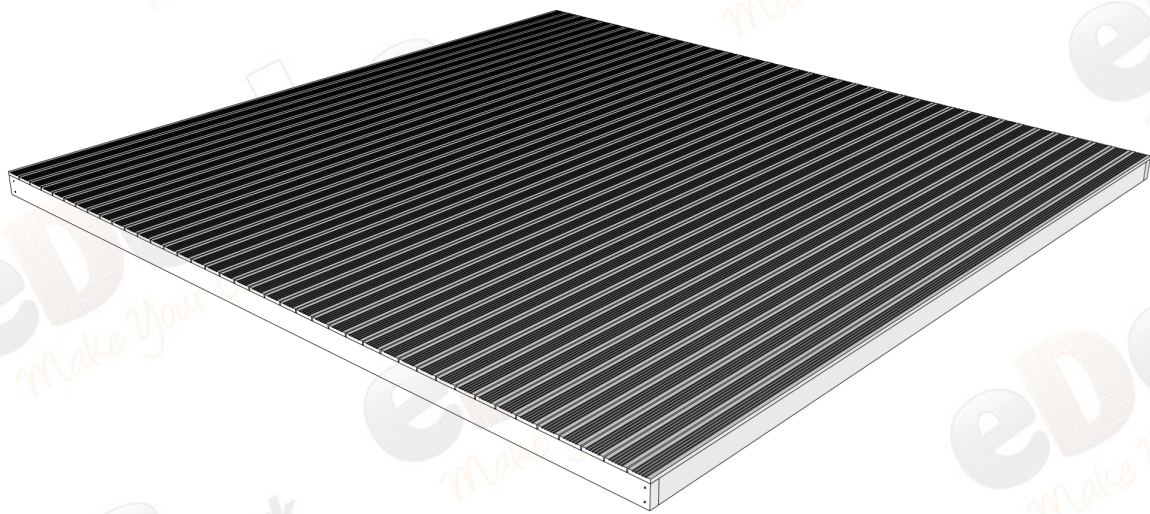



Step 4

HANDRAIL SYSTEM

If your kit has a handrail system please assemble these prior to attaching to the newels.

To fix the spindles you should screw into each spindle from under the baserail and through the top of the handrail using one screw at each end.

Space the spindles so they are evenly spaced with approx 125mm gap between each.

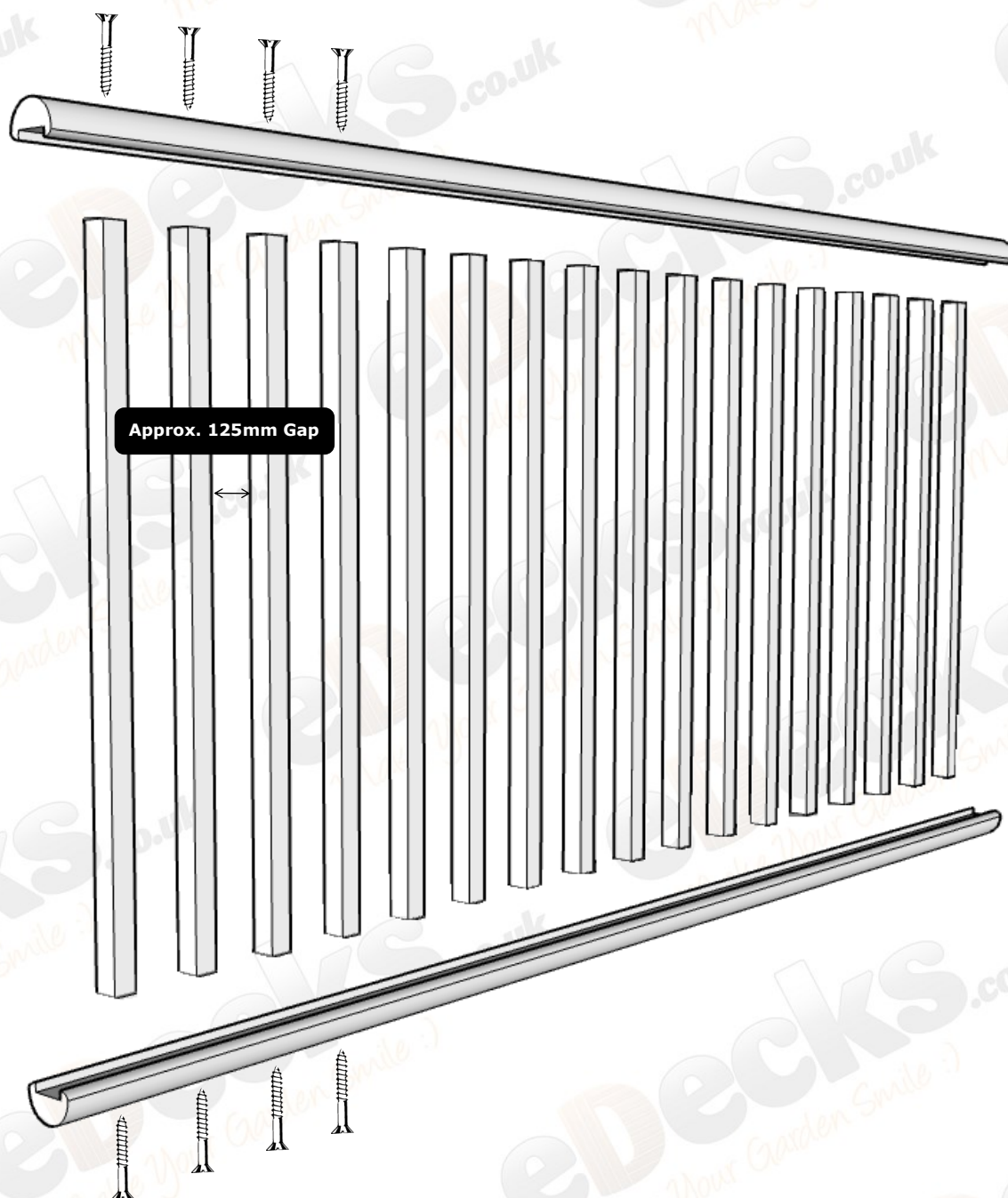

All images are for illustration only. Please see individual item listings for actual item specifications.



Step 4 Cont'd

HANDRAIL SYSTEM

Once all the spindles have been fixed into position, your handrail system should look as per below.

Now that the handrail sections are complete they can be fixed into position on your decking kit, between the newel posts you installed earlier using the angle brackets included in the fixing kit.

Optional: You may wish to use wood filler and stain to hide the imperfections left by the screws.

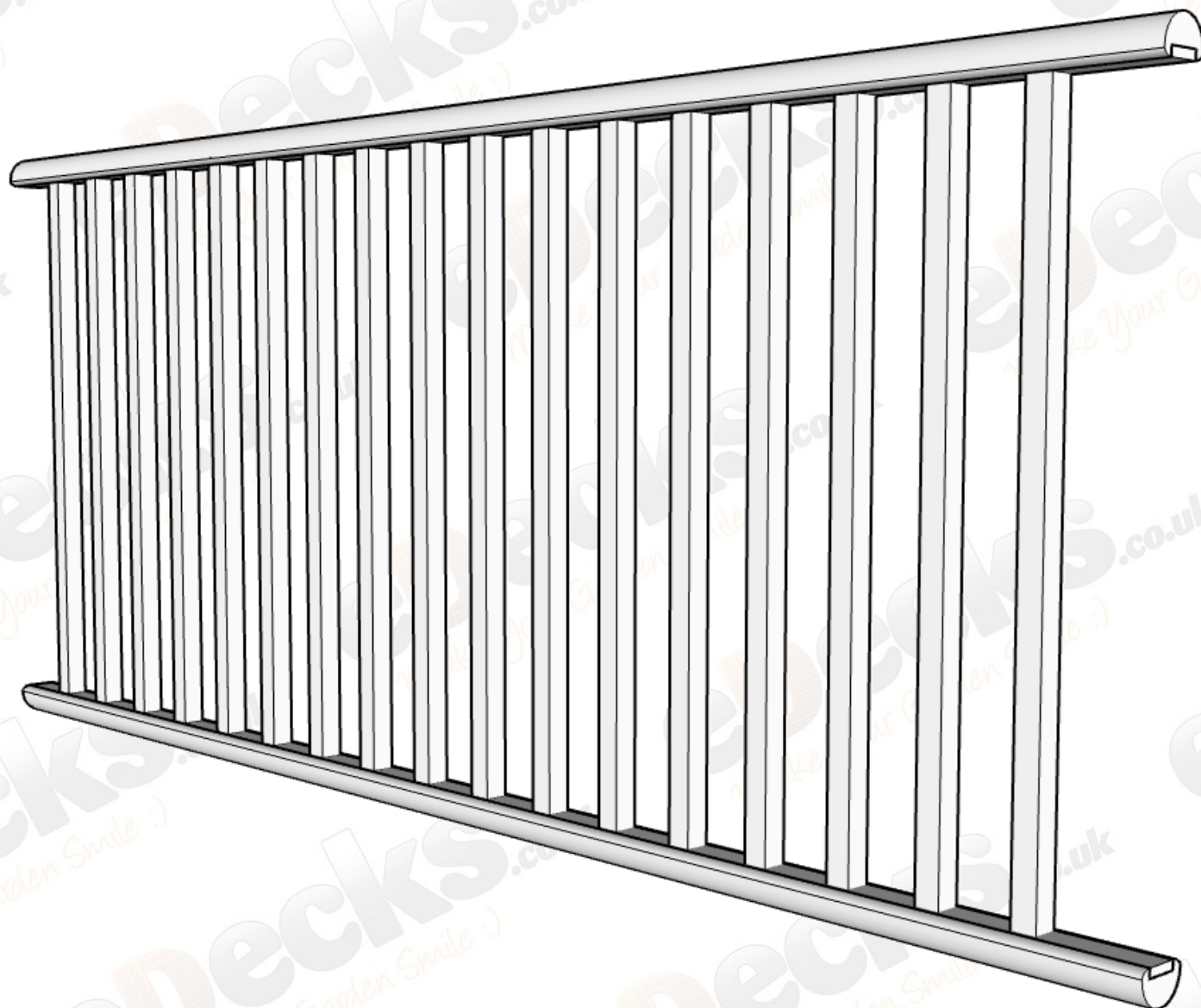

Discount Decking Kit

Fitting Guide



Step 5

HANDRAIL SYSTEM

The final step of your build is to fix the handrails into position as shown below, using the 1 1/2" x 8g screws and brackets that are included as part of the fixing kit.

Once both handrails are secured in place your decking kit build is complete.

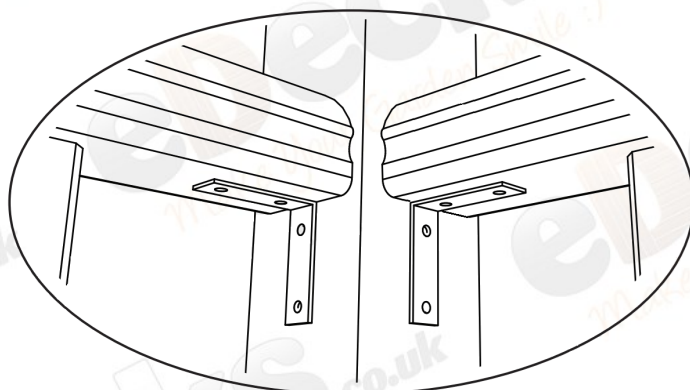

Discount Decking Kit

Fitting Guide

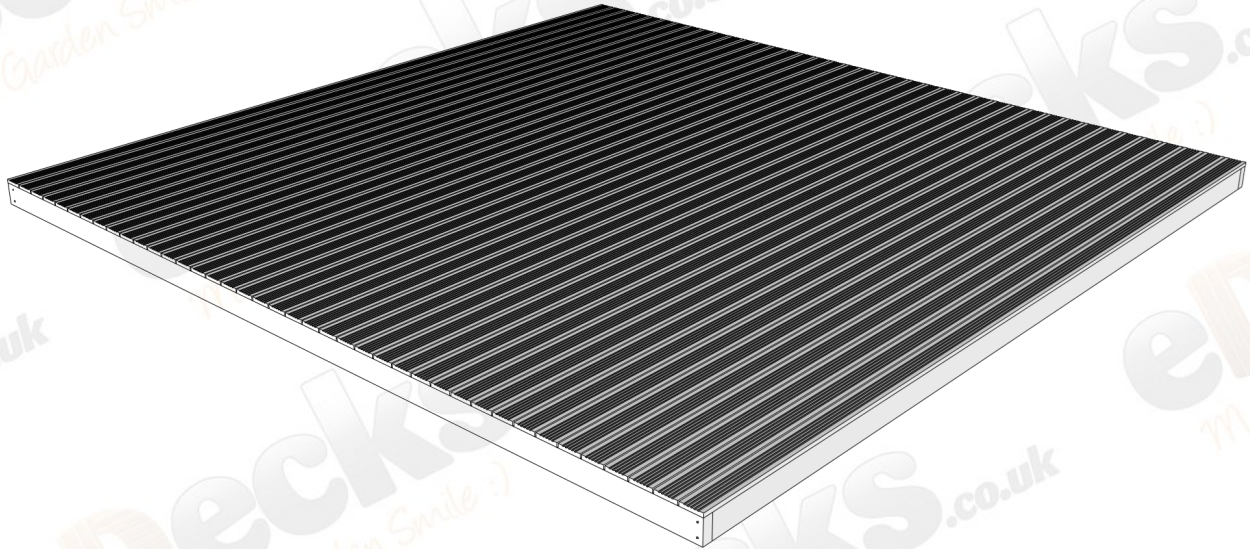
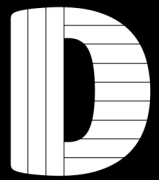

Enjoy your new Decking!

All images are for illustration only. Please see individual item listings for actual item specifications.

Page 9 of 9